



WOODACOUSTICS™



WOODACOUSTICS (Asia) Limited
活士(亞洲)有限公司

WOODACOUSTICS™ panels combines the natural appearance of wood with unique features for high quality acoustics, provides the freedom for Architects & Designers to create new concepts combining contemporary wood finishing design with the need for good acoustics. **WOODACOUSTICS™** panels with the choice of size, pattern, colour and acoustic properties can easily blend in with other decorative features to suit various requirements for boardroom, convention & exhibition venues, meeting areas, auditoria and other important environments which require a good-balance between elegance and good acoustic ambience.

WOODACOUSTICS™ panel consists of two main-series comprising of strips and panelling to suit the most stringent requirements.



5/16/16
Cherry Veneer Finish
Panelling

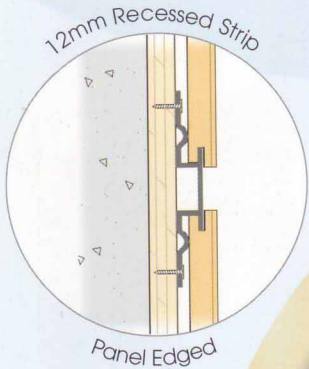

Frequency (Hz)

125	160	200	250	315	400	500	630
0.54	0.47	0.69	0.55	0.49	0.56	0.64	0.64
0.21	0.30	0.49	0.55	0.53	0.56	0.67	0.66

800	1000	1250	1600	2000	2500	3150	4000
0.69	0.70	0.70	0.66	0.63	0.66	0.63	0.58
0.67	0.69	0.70	0.62	0.60	0.58	0.51	0.53

Absorption Coefficient Curve
5/16/16

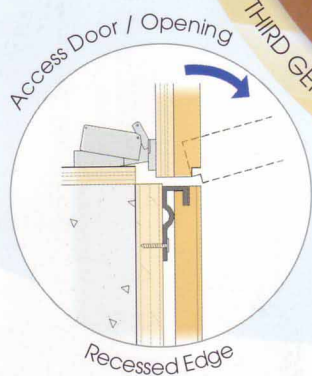
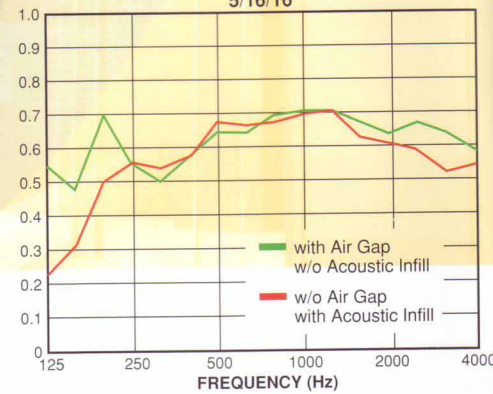



Absorption Coefficient Curve
3/13/V4

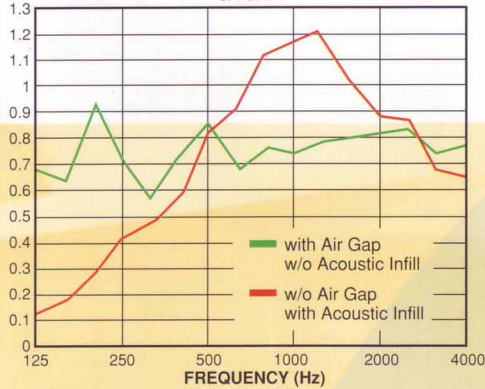

Frequency (Hz)

125	160	200	250	315	400	500	630
0.69	0.63	0.91	0.72	0.57	0.72	0.83	0.68
0.12	0.18	0.28	0.41	0.49	0.59	0.81	0.91

800	1000	1250	1600	2000	2500	3150	4000
0.75	0.74	0.79	0.81	0.83	0.84	0.74	0.76
1.11	1.16	1.21	1.02	0.89	0.88	0.68	0.66

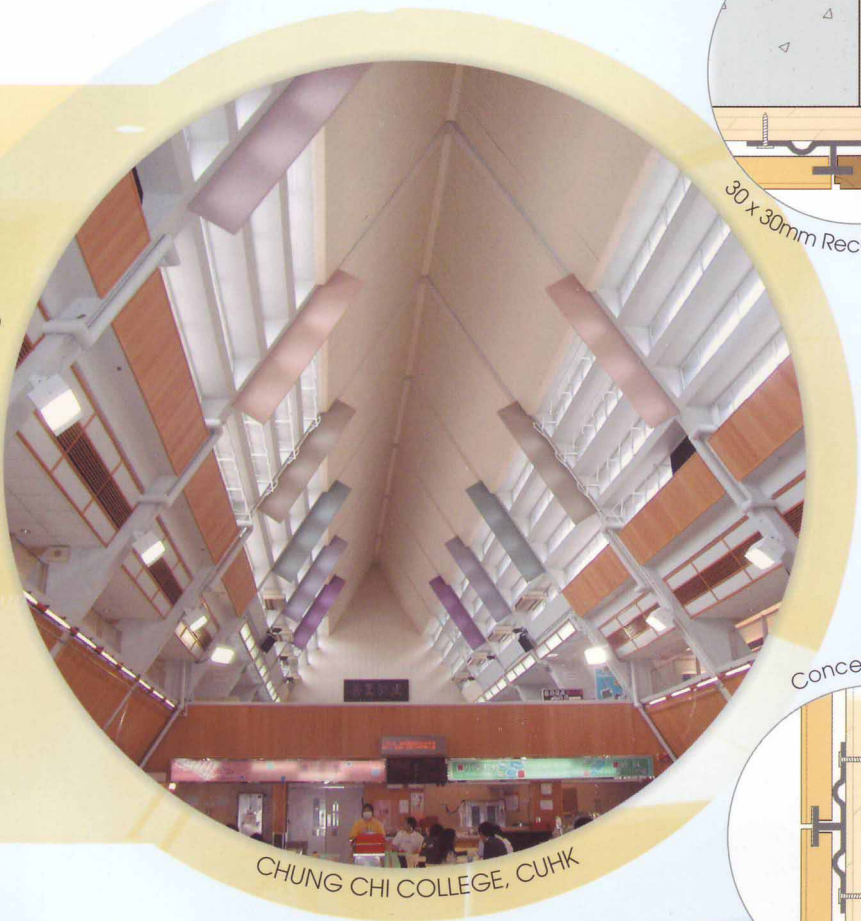
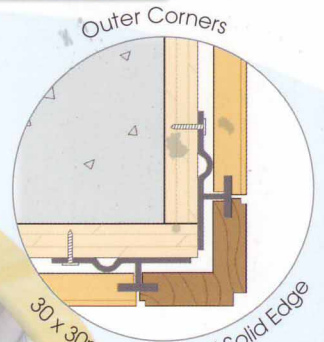

CHUNG CHI COLLEGE, CUHK

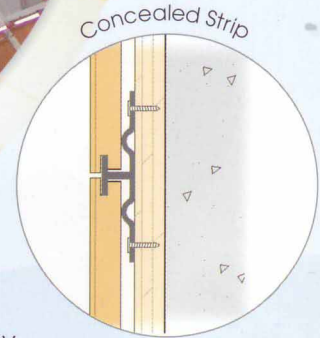

3/13/V4
Stained Beech Finish
Strips

Asked for by
Architects and Interior

Designers without compromise of the flexibility & unique feature in their design and allow a joint-free wall and ceiling application.

More than 75 standard patterns in appearance are available in stock for selection with covering by all kinds of decorative finish including customary real-wood veneer, colour-matched on RAL painting and various melamine coatings.

Apart from the absorptive and reflective design of WOODACOUSTICS™ panels, we are also providing a new generation of acoustical design - WOODACOUSTICS™ Diffusion Series. An impedance change across WOODACOUSTICS™ panel surface could provide diffusion. WOODACOUSTICS™ Diffusion Series provide Architect, Designer and Acoustic Consultant the flexibility to improve the acoustic quality other than by absorption and reflection. WOODACOUSTICS™ Diffusion Series partially absorb the sound energy and then the reflected energy is diffused.

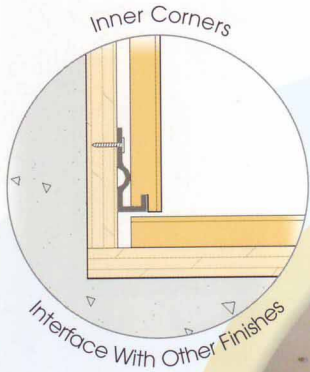

ST. JEROME'S CHURCH, TSW

Absorption Coefficient Curve against Free Area %

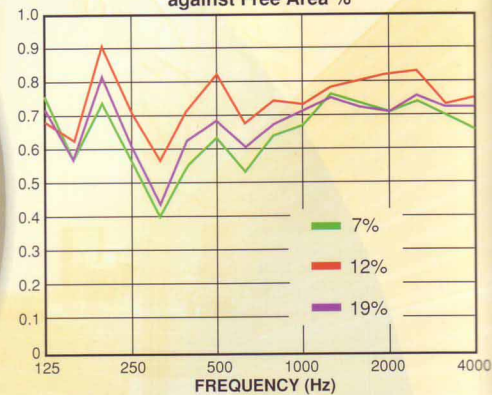

Frequency (Hz)	125	160	200	250	315	400	500	630
7%	0.77	0.58	0.75	0.58	0.40	0.56	0.64	0.54
12%	0.69	0.63	0.91	0.72	0.57	0.72	0.83	0.68
19%	0.73	0.57	0.82	0.62	0.44	0.63	0.69	0.61

Frequency (Hz)	800	1000	1250	1600	2000	2500	3150	4000
7%	0.65	0.68	0.77	0.75	0.72	0.75	0.70	0.66
12%	0.75	0.74	0.79	0.81	0.83	0.84	0.74	0.76
19%	0.68	0.72	0.76	0.73	0.72	0.76	0.73	0.73

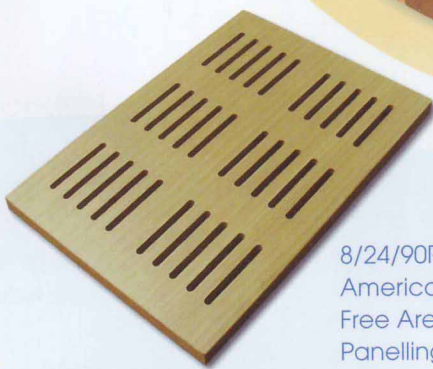

8/24/90R
American Cherry Finish
Free Area 17%
Panelling

Construction of Strips

1. Plurality Slots/Holes
2. Tailor-made Bevel Chamber
3. Air Flow Resistance Membrane

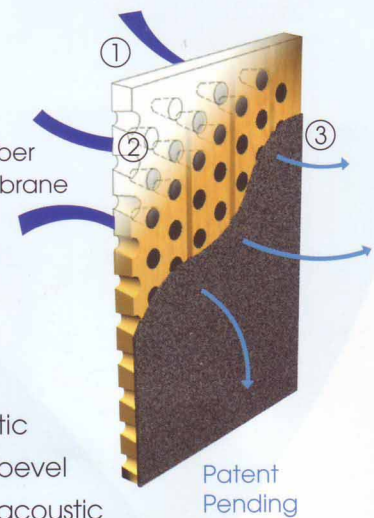

Patent Pending

Unique Design in Acoustics

Through sophisticated research and continuous development, an innovative concept was established and patented for the achievement of excellent acoustic performance by means of interchange of different acoustic flow-resistance membrane as **SoundTex®** behind the tailor-made outlet bevel chamber through-out the **WOODACOUSTICS™** panel without any usage of acoustic infill or in minimum, (i.e. mineral wool or fiberglass) which is in compliance with the latest requirement by International Health Regulation.

Innovative in Construction

Utilizing state-of-the-art acoustical computer software and simulation. All kinds of perforation and pattern facing with various flow resistance membrane as **Soundtex®** sandwiched by Honey-Comb substrate were both modelled and verified by means of both computer and HOKLAS accredited acoustic laboratory. **WOODACOUSTICS™** panel is dedicated to enhancing product reliability and flexibility and to ensure that the performance of products are both accurate and credible.



3/7/90
Beech Finish
Panelling

Absorption Coefficient Curve
3/7/90

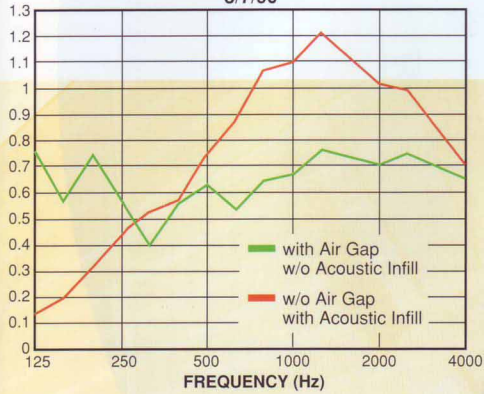

Frequency (Hz)

125	160	200	250	315	400	500	630
0.77	0.58	0.75	0.58	0.40	0.56	0.64	0.54
0.14	0.20	0.32	0.44	0.53	0.57	0.75	0.89
800	1000	1250	1600	2000	2500	3150	4000
0.65	0.68	0.77	0.75	0.72	0.75	0.70	0.66
1.08	1.11	1.22	1.13	1.03	1.00	0.85	0.71

Construction of Panelling

1. Perforated Front Panel
2. Air Flow Resistance Membrane
3. Honey-Comb / Hollow Configuration
4. Aligned/Scattered Bottom Panel
5. Air Flow Restriction Membrane

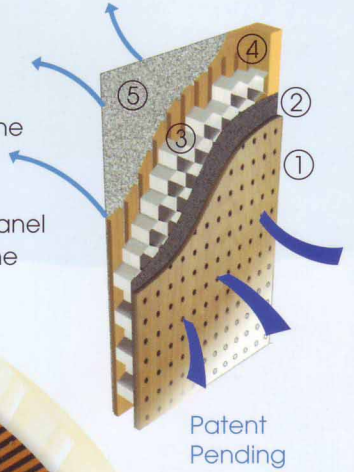

Patent Pending



SKH ST. JOHN BAPTIST CHURCH, TKO

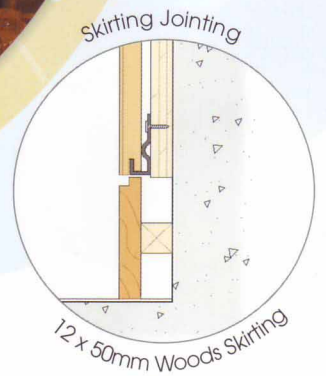
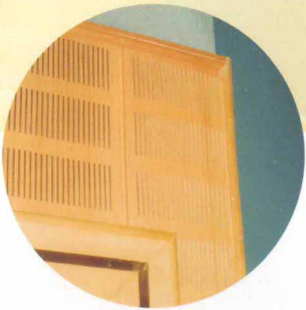

12 x 50mm Woods Skirting

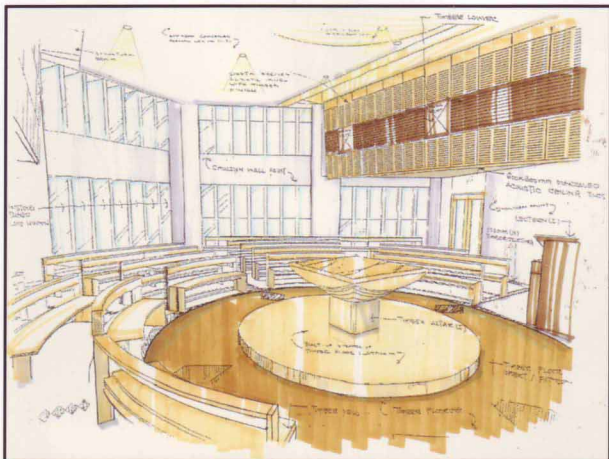

Environmental friendly

The core material of **WOODACOUSTICS™** complies with the latest requirement of Class A MDF E1 in which Formaldehyde Emission does not exceed 8mg/100g in accordance to EW120 specification.

WOODACOUSTICS™ core can be manufactured by various environmental friendly material i.e. MDF-H/E Grade High Damp/Exterior Used, Fire-retardant MDF-FR to suit world-wide regulation in fire safety. Fire Hazard is also a great concern for most clients. Fire Retardant finish is applied on all **WOODACOUSTICS™** panel to comply with worldwide fire requirement.

The progress of production, distribution, construction, demolition, bi-product and disposal of waste are strictly monitored and addressed in alternative ways that complied with the requirement of ISO standard for environmental policy.

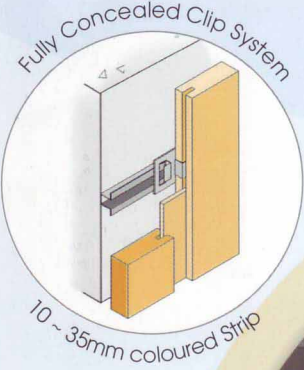

2/6/500
Plastic Laminated
Woodgrain Finish
Hollow Configuration
Panelling



Absorption Coefficient Curve
2/6/500

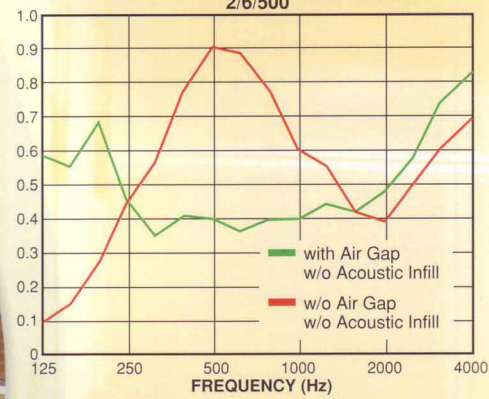

125	160	200	250	315	400	500	630
0.59	0.56	0.69	0.45	0.35	0.41	0.40	0.37
0.11	0.17	0.29	0.46	0.59	0.80	0.92	0.90

800	1000	1250	1600	2000	2500	3150	4000
0.40	0.40	0.44	0.42	0.48	0.58	0.74	0.82
0.79	0.62	0.57	0.43	0.41	0.51	0.62	0.70

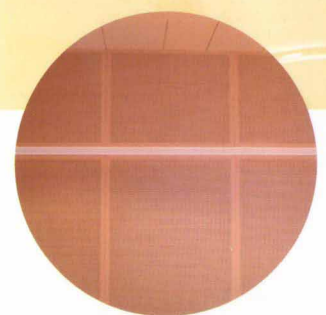
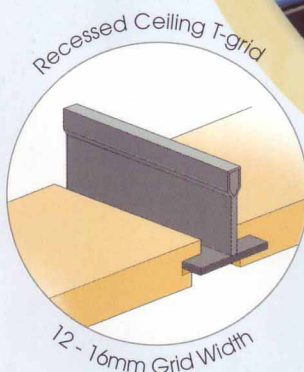

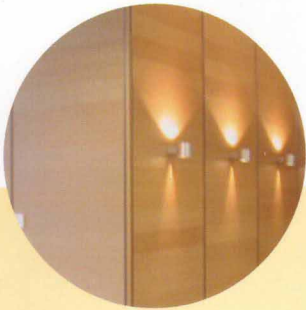

Square Edge

Diffusion Coefficient Curve

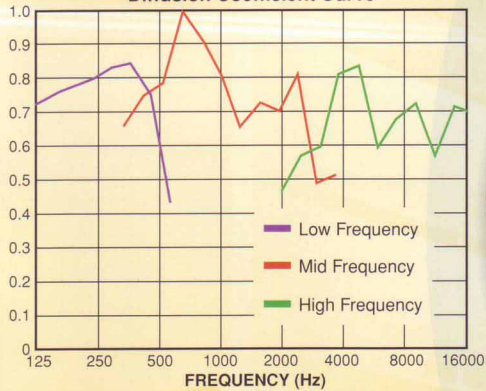

Frequency (Hz)

125	150	200	250	315	400	500	600
0.72	0.75	0.77	0.79	0.82	0.83	0.75	0.45
800	1000	1200	1600	2000	2400	3200	4000
0.90	0.80	0.65	0.72	0.70	0.80	0.50	0.52
4800	6400	8000	9600	12800	16000	19200	25600
0.82	0.60	0.68	0.72	0.57	0.71	0.64	0.60

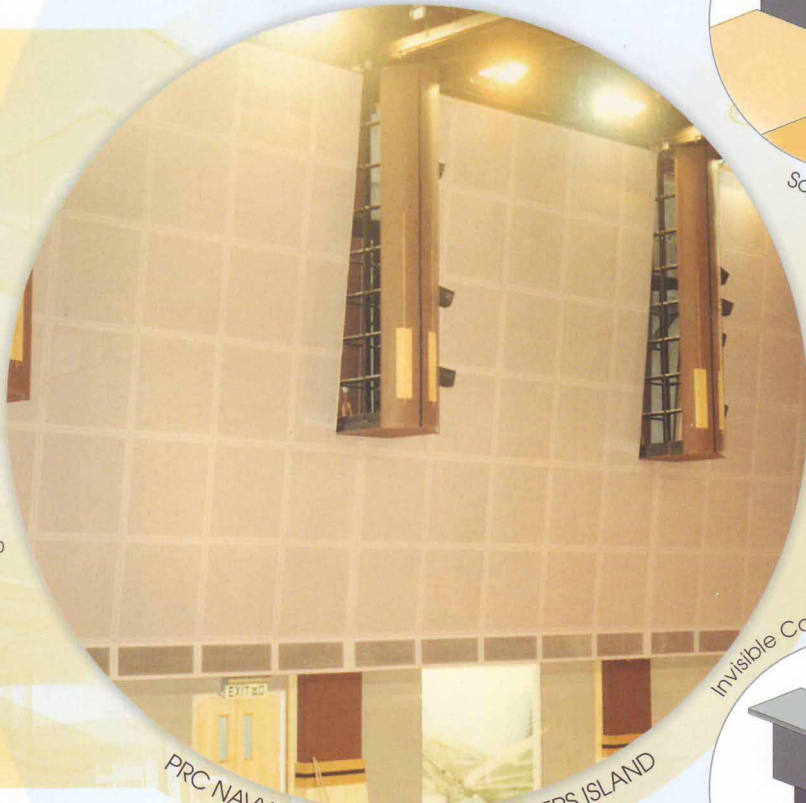

PRC NAVY BARRACKS, STONE CUTTERS ISLAND

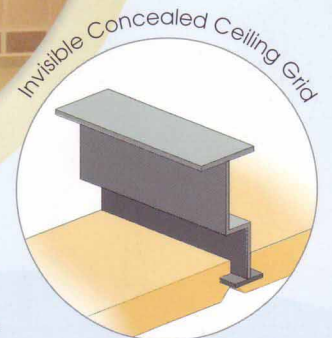

Bevel Edge



2D-Diffusion Panel
Oak Finish Strips

Ceiling & Wall assembly

WOODACOUSTICS™ panels are mounted by means of unique system of concealed and semi-recessed clip system which have been successfully used in more than 1000 applications without compromise of maintenance, and are easy to install and with excellent aesthetic appearance.

Unlimited Size & Shapes

All kinds of size and profiles of shapes can be custom-made in terms of up to 3000mm irregular shapes long panel or in 3-10m radius curve panel in concave or convex manner.

Technical data	Thickness	: nominated 9 to 18mm
	Strips	: modulus from 192mm to unlimited width 2400, 3000, 3600 standard length
	Panelling	: 300mm to 3600mm in length or width
	Surface Density	: 4 to 12kg/sq.m
	Flow-resistance Membrane:	Soundlex® Non-woven Fabric
	Fire Resistance	: BS476 Part7
	Surface Treatment	: UV-tempered clear varnish, brilliance value of 25 or customized
	Acoustical Performance	: Absorption Type NRC 0.3 to 1.0 Diffusion Type DI 0.7 to 1.0

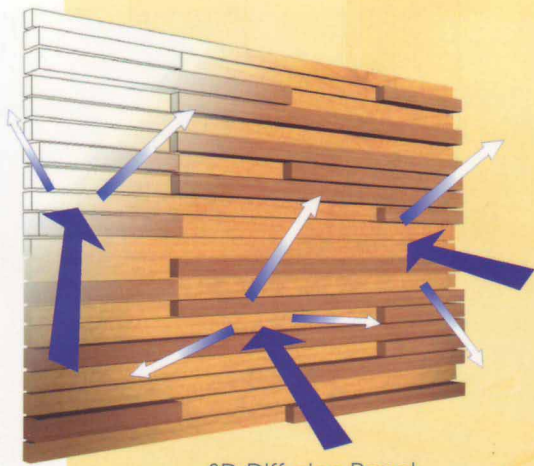

3D-Diffusion Panel
RAL Colour Painted
Panelling



At least 6.5 sq.m. samples of
WOODACOUSTICS™ panel is tested in
200 cu.m. volume Reverberation Chamber in
compliance to ASTM C 423-02
standard by Independent HOKLAS
Accredited Laboratory.
(Report No.: APJ03-006-RP002)

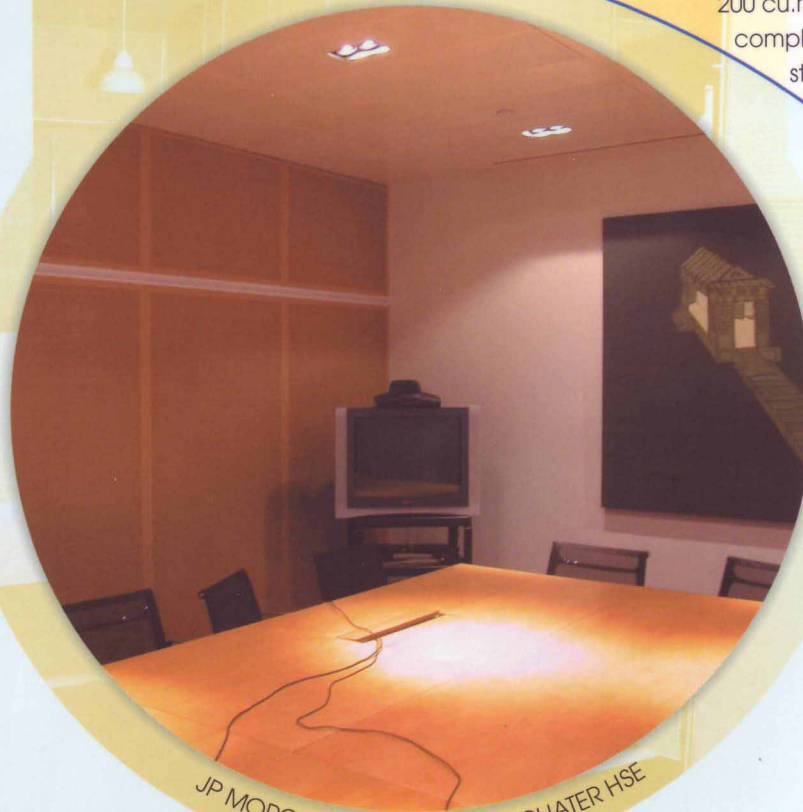

JP MORGAN HEADQUARTER, CHATER HSE



Your **WOODACOUSTICS™** representative:

**ARCHITECTURAL
ACOUSTICS**

(INTERNATIONAL) LIMITED

2/F., Po Cheong Commercial Building,
29 Prat Avenue, Tsimshatsui, Hong Kong.
Tel: (852) 2367 3232 Fax: (852) 2724 8001
E-mail address: sales@aa-hk.com.hk



WOODACOUSTICS™